



LAWN & GARDEN

MODEL N° 0112

OWNER'S MANUAL

Keep this Product ID Number and use when contacting Customer Service:

REGISTER YOUR LIFETIME PRODUCT TODAY!

There are benefits to registering your Lifetime product. With our new online product registration form, it's fast and easy! Register with us at www.lifetime.com and enjoy these great benefits:

- Receive exclusive money-saving offers from BuyLifetime.com, our online store, as well as NEW product notifications and special closeout promotions!
- In the unlikely event of a product recall or safety modification, we will notify you.
- Registering your product guarantees you warranty service. If you do not register your product, your warranty rights will not be diminished. But you will need to provide a sales receipt to verify your product purchase date before warranty service will be provided.

LIFETIME'S PROMISE TO YOU:

Maintaining your privacy is our long-standing policy at Lifetime. And you can rest assured that Lifetime will not sell or provide your personal data to other third parties, or allow them to use your personal data for their own purposes.

We invite you to read our privacy policy at www.lifetime.com

REGISTER today!

Save this instruction in the event that the manufacturer has to be contacted for replacement parts.

****U.S. and Canada customers ONLY****

IF ASSISTANCE IS NEEDED,

DO NOT CONTACT THE STORE!

CALL OUR CUSTOMER SERVICE DEPARTMENT at 1 (800) 225-3865

HOURS: 7:00 a.m. to 5:00 p.m. Monday through Friday (Mountain Standard Time)

Call, or visit our Web site for Saturday hours

For customers outside the U.S. or Canada, please contact the store for assistance.



SAFETY INSTRUCTIONS



FAILURE TO FOLLOW THESE WARNINGS MAY RESULT IN SERIOUS INJURY OR PROPERTY DAMAGE AND WILL VOID WARRANTY.

To ensure safety, do not attempt to assemble this product without following the instructions carefully. Check entire box and inside all packing material for parts and/or additional instruction material. Before beginning assembly, read the instructions and identify parts using the hardware identifier and parts list in this document. Proper and complete assembly, use and supervision are essential to reduce the risk of accident or injury.

- Do not use or store hot objects such as grills, blowtorches, welding equipment, etc. near the product.
- If using a ladder during assembly, use extreme caution.
- Two capable adults are required for assembly. (It is also recommended that a third adult function as an instruction reader.)

Most injuries are caused by misuse and/or not following instructions. Use caution when using this product.

STOP!

BEFORE BEGINNING ASSEMBLY

STOP!



Keep the hardware bags and their contents separate. If any parts are missing, call our Customer Service Department.



Identify and inventory all parts and hardware using the parts and hardware lists and identifiers in this document.



TOOLS REQUIRED FOR ASSEMBLY

Phillips Screwdriver

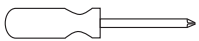

(1)

Safety Glasses

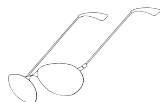

(1 for each person)

ASSEMBLY GUIDES

Refer to the following areas throughout the instructions to assist in the assembly process:

This area is located at the top, left-hand corner of the page and indicates which tools and hardware are needed to complete the assembly steps on a page.



This area is located at the top, right-hand corner of the page and shows an image of the product with shaded parts indicating which section is being assembled.

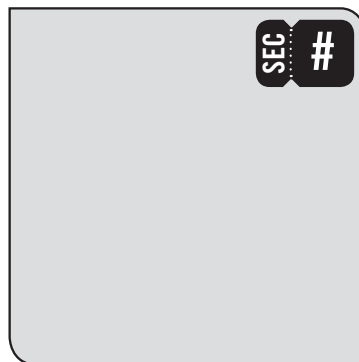

This area is usually located in the bottom, left-hand corner of a step and indicates that special attention is needed to perform a particular part of a step.



These areas are usually located in the bottom, right-hand corner of a step and indicate that damage to the product or serious injury may occur if the caution or warning is not heeded.



PARTS & HARDWARE LIST

| ID | Description | Quantity |
|---|--|----------|
| Main Hardware | | |
| AYJ | Battery Powered Light | 2 |
| BHB Shed Light Hardware [1048437] x2 | | |
| ADZ | 1/4" x 5/8" Pan-Head Screw (Not all screws are used) | 3 |

PARTS & HARDWARE IDENTIFIER

SHED LIGHT HARDWARE [BHB] x2

Hardware is shown at actual size

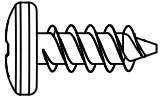

ADZ (x3)
1/4" x 5/8" Pan-Head Screw
(Not all screws are used)

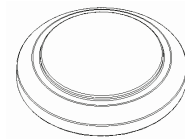

AYJ (x2)
Battery Powered Light



TOOLS AND HARDWARE REQUIRED FOR THIS PAGE

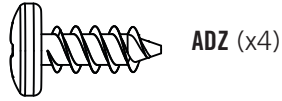
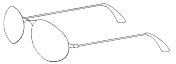

SEC 1

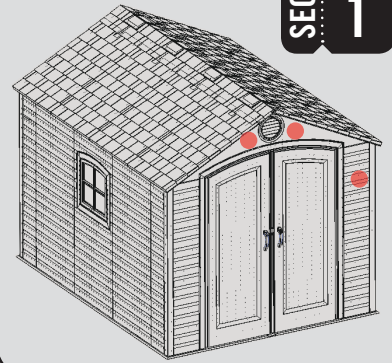

SEC

BATTERY POWERED LIGHT INSTALLATION

1.1

The **Battery Powered Light (AYJ)** can be installed above the Right Corner Shelf (on 8' Sheds) or on the Front Gable. Insert two (2) **1/4" X 5/8" Pan-Head Screws (ADZ)** half-way into the pilot holes on the Corner Wall Panel or Front Gable. Hang Light on Screws.

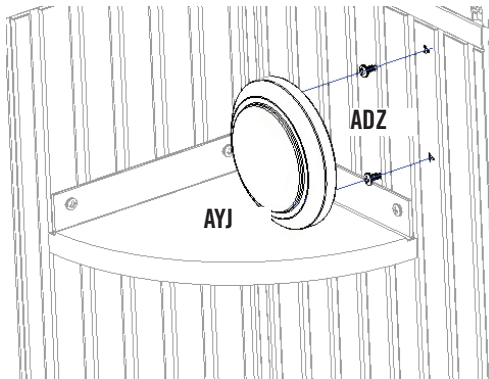

Battery Light Features:

- Adjustable Timer
- Auto shutoff
- Battery powered
- Easy on/off
- Easy mounting

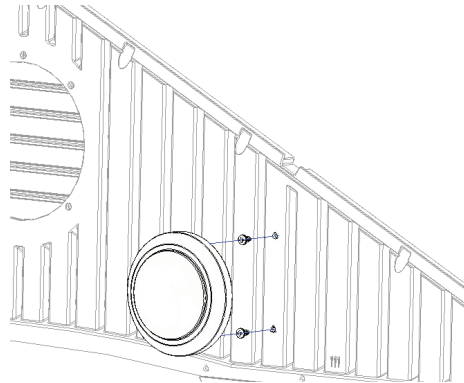
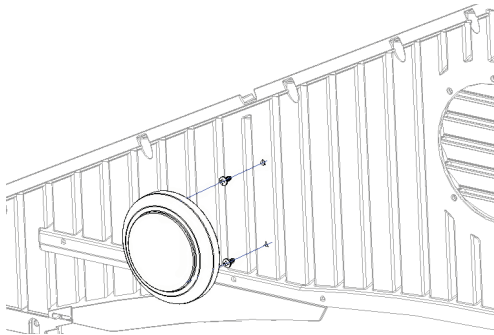

Note: Open the battery compartment and remove the plastic cap between the battery and the metal contact.

REPEAT THIS STEP FOR THE SECOND LIGHT

ENHANCE YOUR LIFETIME® PURCHASE BY ADDING ACCESSORIES OR OTHER GREAT PRODUCTS:

To purchase accessories or other Lifetime Products, visit us at:

www.lifetime.com

Or call: 1-800-424-3865

